



# INSTALLATION INSTRUCTIONS

## IMPORTANT

Before assembling your access lighting fixture, please make sure that you carefully read through these instruction sheets. Consider having your fixture installed by a qualified licensed electrician.

**NOTE:** The important safeguards and instructions that appear in this manual are not meant to cover all possible conditions and situations that may occur. It must be understood that common sense, caution and care, are factors that can't be built into any product. These factors must be supplied by the person(s) caring for and operating the fixture.



## GENERAL INFORMATION

All electrical connections must be in accordance with all ordinances, Local and National Electrical Codes. These fixtures are intended for mounting to a standard 4" x 2 1/2" metal octagon outlet box. The box must be directly supported by the building structure and U.L. Recognized.

## STEP BY STEP INSTRUCTIONS

Before starting your installation disconnect the Power by turning off the Circuit Breaker or by removing the fuse at the fuse box. Just turning the light off at the light switch is not sufficient to prevent electrical shock.

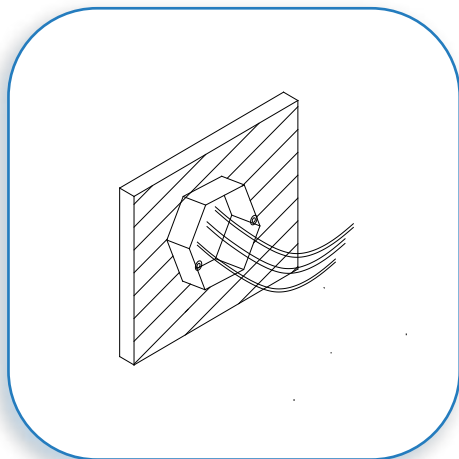

**COLLECTION**  
EVIA

**APPLICATION**  
Wall Fixture

**MODEL NO.**  
62289

### WHAT WE PROVIDE

- Mounting Hardware
- Crossbar Plate
- 4 x Crystal shade
- 4 x 48W XENON G9

### WHAT YOU NEED

- Screwdriver
- Wire Cutters
- Wiring Supplies as Specified by Electrical Code

1

### PREPARE FIXTURE

If there is an existing fixture remove it. Expose the supply wire from the J-box.

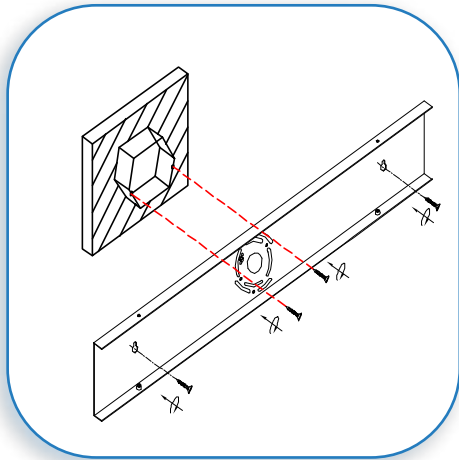

2

### MOUNT CROSSBAR PLATE

Gently pull the supply wires out of the J-box. Mount the crossbar to the J-box with the supplied screws.

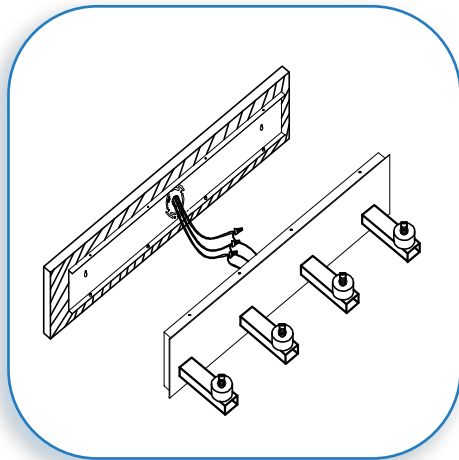

3

### MAKE WIRE CONNECTIONS

Gently pull the supply wires through the hole in the crossbar. Connect the black supply wire to the black fixture wire. Secure with the supplied wire nuts. Connect the white supply wires to the white fixture wire. Secure with the supplied wire nuts. Either wrap the green wire around one of the protruding screws or connect it to the supply ground wire. Secure all wire with electrical tape (not supplied). Tuck all wires carefully into the J-Box.

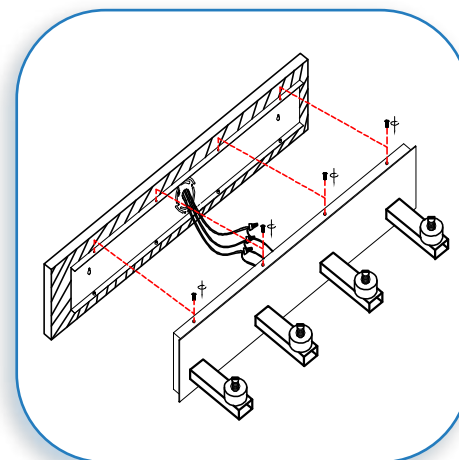

4

### MOUNT FIXTURE TO THE CROSSBAR PLATE

Position the fixture plate over the crossbar plate. Align the holes at the top and bottom of the plates. Secure with the supplied screws.

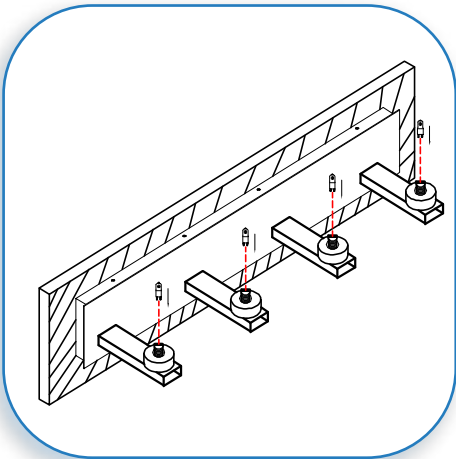

5

**INSERT THE BULBS**

Insert the supplied bulbs.

MAXIMUM WATTAGE 48W.

DO NOT EXCEED THE WATTAGE AS STATED

ON THE WARNING LABEL AND IN THE INSTRUCTION SHEETS

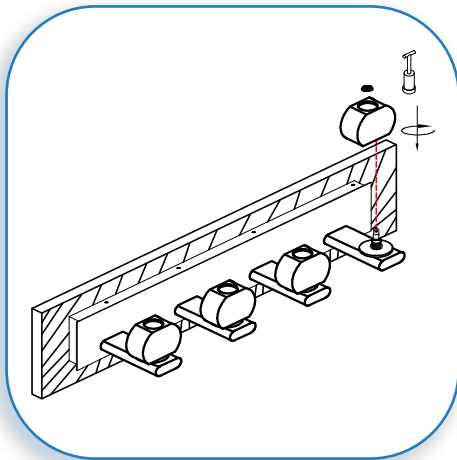

6

**SECURE THE CRYSTAL SHADE**

Place the crystal shade over the socket and secure with the supplied socket ring.



7

**RESTORE THE ELECTRICITY AND CHECK THE OPERATION OF YOUR NEW ACCESS FIXTURE**

**CAUTION** Please ensure that the fitting is cool and switched off before replacing the bulb. DO NOT use bulbs that might exceed the maximum wattage, stated on caution label.